



SV SensTech
— 华景传感科技 —

Data Sheet

Version 1.2/May 2022

ML-4259-3729-T1S1

拥有核心芯片技术的MEMS传感技术公司

A MEMS Sensor Company with Advanced Core Chip Technology



上海

芯片研发：上海张江



无锡

研发测试中心：无锡高新区



北京

华北销售中心：北京海淀



德国

芯片研发：斯图加特



苏州

封测生产：苏州高新区



深圳

华南销售中心：深圳南山



Product Specification

ML-4259-3729-T1S1 Top -port analog silicon microphone

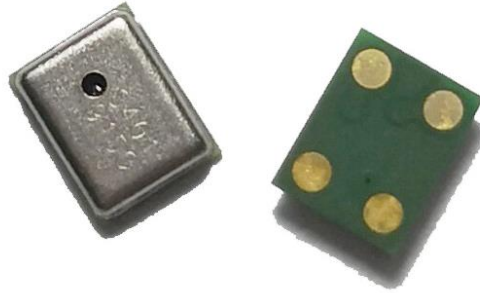

● Description

ML-4259-3729-T1S1 is high-performance top-port analog silicon microphone that receives the sound signal from the top side hole on lid. By using our own innovative and unique MEMS silicon microphone chip design, MicroLink Senstech provides a series of packaged MEMS silicon microphones with compact size to achieve high performance such as high SNR, high sensitivity, excellent reliability and broad frequency response. This series of MEMS microphones find wide applications in cell phones, tablets, wearable devices and other portable electronic devices.

● Features

- Compact size of $3.76 \times 2.95 \times 1.1 \text{ mm}^3$
- Sensitivity of -42 dBV/Pa ($\pm 1 \text{ dBV/Pa}$)
- High signal-to-noise ratio of 59 dB
- Extremely low THD of 0.1% at 94 dB SPL
- High acoustic overload point of 133 dB SPL
- High immune to RF/EM interference
- High mechanical strength
- High temperature resistance
- Excellent reliability

● **Applications**

Cell phones/smartphones, tablets, learning machines/game stations, MP3/DC/DV, computers/laptops, Bluetooth headsets/headphones, wearable smart systems, Iot related devices, etc.



● **Absolute maximum ratings**

Supply voltage: VDD to GND -0.3V~5V

ESD Tolerance:

Lid Mode 8kV

I/O Pin Mode 4kV

Temperature Characteristics					
Parameter	Conditions	Min	Typ.	Max	Unit
Operating Temperature		-40		+85	°C
Storage Temperature	Solder on PC board	-40		+105	°C
	In Tape and Reel	-10		+50	°C

● Acoustic and electrical specifications

Test conditions: 23°C±2°C, 55%±5% R.H., VDD=1.8V, no load, unless otherwise indicated

Parameter	Symbol	Condition	Min.	Typ.	Max	Unit
Sensitivity	Sens	94dB SPL @1kHz	-43	-42	-41	dBV/Pa
Signal to Noise Ratio	SNR	20Hz to 20KHz, A-weighted	-	59	-	dB(A)
Output Impedance	Z _{out}	@ 1 kHz	-	-	300	Ω
Supply Voltage	V _{DD}		1.6	-	3.6	V
Current Consumption	I _{DD}		-	110	130	μA
Dimension			3.76×2.95×1.1			mm
Directivity			Omnidirectional			
Frequency Response	F		100~10k			Hz
Power Supply Rejection	PSR	217Hz, 0.1Vpp Square on VDD	-	-100	-	dBV(A)
Power Supply Rejection Ratio	PSRR	200mVpp sinewave @ 1 kHz	-	66	-	dB
Total Harmonic Distortion	THD	94 dB SPL @ 1kHz	-	0.1	-	%
		114 dB SPL @ 1kHz	-	0.5	-	%
Acoustic Overload Point	AOP	1% THD @ 1kHz	-	129	-	dB SPL
		10% THD @ 1kHz	-	133	-	dB SPL

● Frequency response

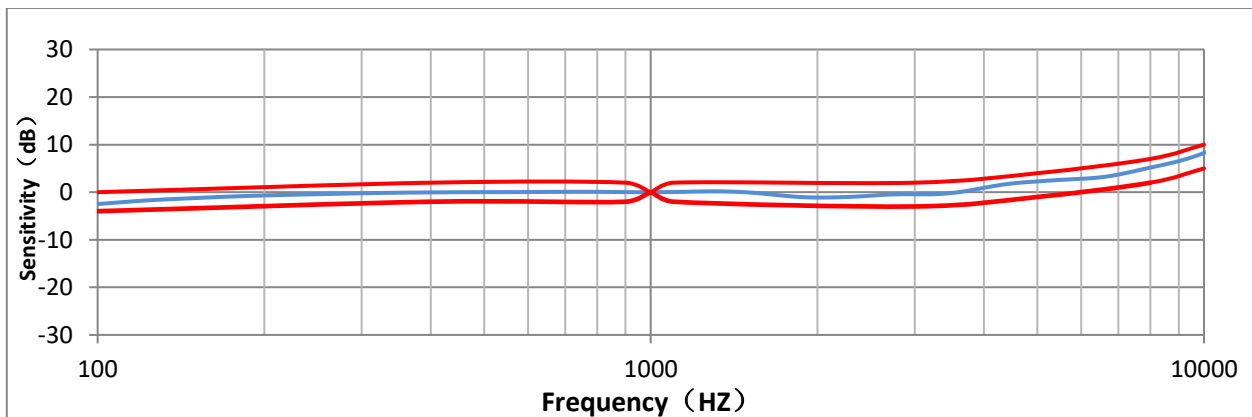

	100	400	900	1000	1100	3000	5000	8000	10000
USL	0	2	2	0	2	2	4	7	10
LSL	-4	-2	-2	0	-2	-3	-1	2	5

Figure 1. Typical free field frequency response (Normalized to 1 KHz)

● **Mechanical specifications**

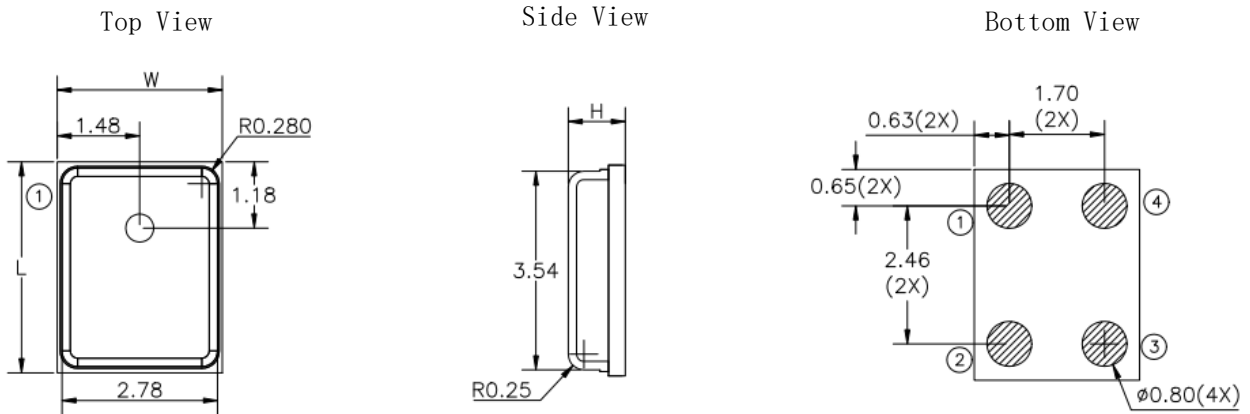

Dimension		
Item	Dimension	Tolerance
Length(L)	3.76 mm	± 0.1 mm
Width(W)	2.95 mm	± 0.1 mm
Height(H)	1.10 mm	± 0.1 mm
AP	0.5mm	± 0.05 mm

Pin #	Pin Name	Description
①	V _{DD}	Power
②	GND	Ground
③	GND	Ground
④	V _{OUT}	Signal output

Figure 2. Detailed mechanical drawings

● **Application circuit diagram**

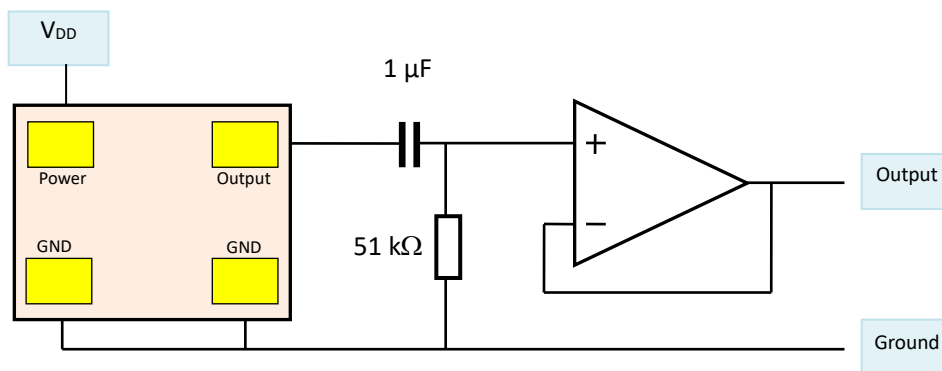

● Example land pattern

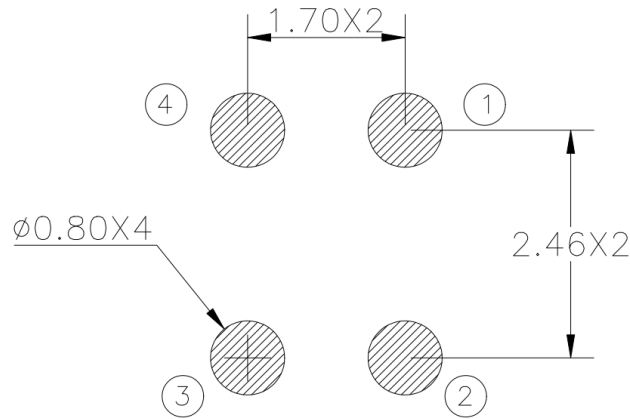
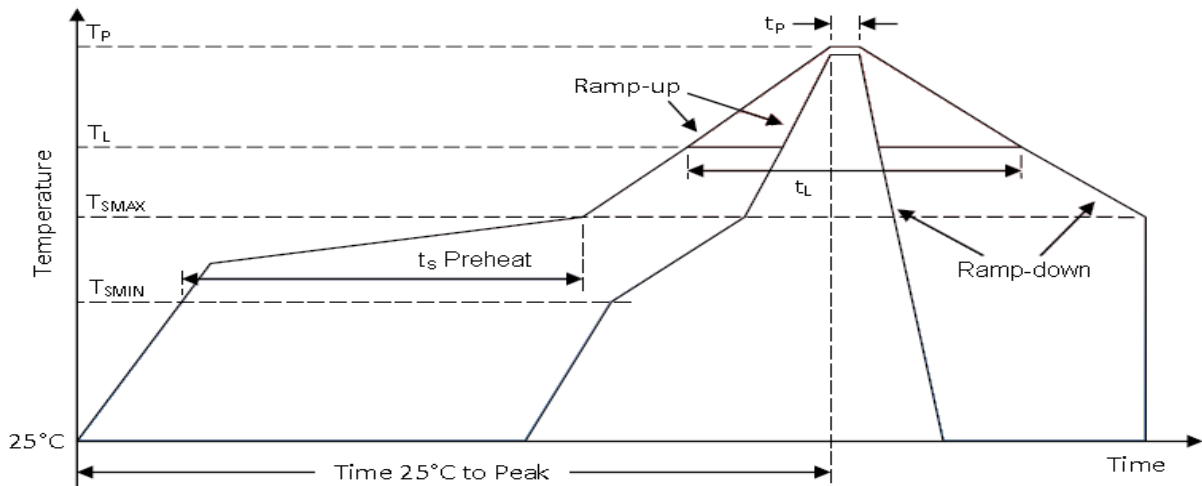

Figure 3. Recommended landing pattern on customers' PCB

● Recommended reflow profile



Description		Parameter (lead-free)
Average temperature change rate (T_{SMAX} to T_P)		3°C/second max.
Preheat	Minimum temperature (T_{SMIN})	150°C
	Maximum temperature (T_{SMAX})	200°C
	Time (T_{SMIN} to T_{SMAX}) (t_s)	60-180 seconds
Reflow	Temperature (T_L)	217°C
	Time (t_L)	60-150 seconds
Peak temperature	Temperature (T_P)	260°C
	Time (t_p)	20-40 seconds
Cooling rate (T_P to T_{SMAX})		6°C/second max
Time required from 25°C to peak temperature		8 minutes max

Figure 4. Recommended leadless solder reflow temperature profile

Notes:

- 1) The air blow speed during reflow process should be low to avoid impurity entering the acoustic hole during reflow process.
- 2) Do not wash or clean the product to avoid impurity entering the product.
- 3) Do not carry out the reflow process more than 5 times. If the melting point of solders is lower, the peak temperature should be accordingly reduced.

● Reliability specifications

Test Item	Description
Temperature/Humidity Bias	168 hours at +85°C/85% R.H. under bias (JESD22-A101A-B)
Thermal shock	100 cycles air-to-air thermal shock from -40°C to +125°C with 15minute soaks. (IEC 68-2-4)
High Temperature Storage	168 hours at +105°C environment(IEC 68-2-2)
Low Temperature Storage	168 hours at -40°C environment(IEC 68-2-1)
High Temperature Bias	1,000 hours at +105°C under bias(IEC 68-2-2)
Low Temperature Bias	1,000 hours at -40°C under bias(IEC 68-2-1)
Drop test	Using 150g fixture, 3 drops along each of 6 axes from 1.5m height onto slippery marble floor (IEC 68-2-27)
ESD-HBM	3 discharges of ± 4 kV direct contact to I/O pins. (MIL 883E, Method 3015.7)
ESD-LID/GND	3 discharges of ± 8 kV direct contact to lid while unit is grounded. (IEC 61000-4-2)
ESD-MM	3 discharges of ± 200 V direct contact to I/O pins. (ESD STM5.2)
Vibration test	4 cycles of 20 to 2,000 Hz sinusoidal sweep with 20 G peak acceleration lasting 12 minutes in X, Y, and Z directions (Mil-Std-883E, Method 2007.2 A)
Reflow test	5 reflow cycles with peak temperature of +260°C
Mechanical Shock	3 pulses of 10,000 G in the X, Y, and Z direction (IEC 68-2-27, Test Ea)

Notes: After reliability tests are performed, the sensitivity of the microphones shall not deviate more than 3 dB from its initial value. After 3 reflow cycles, the sensitivity of the microphone shall not deviate more than 3dB from its initial value.

● Packaging and marking detail

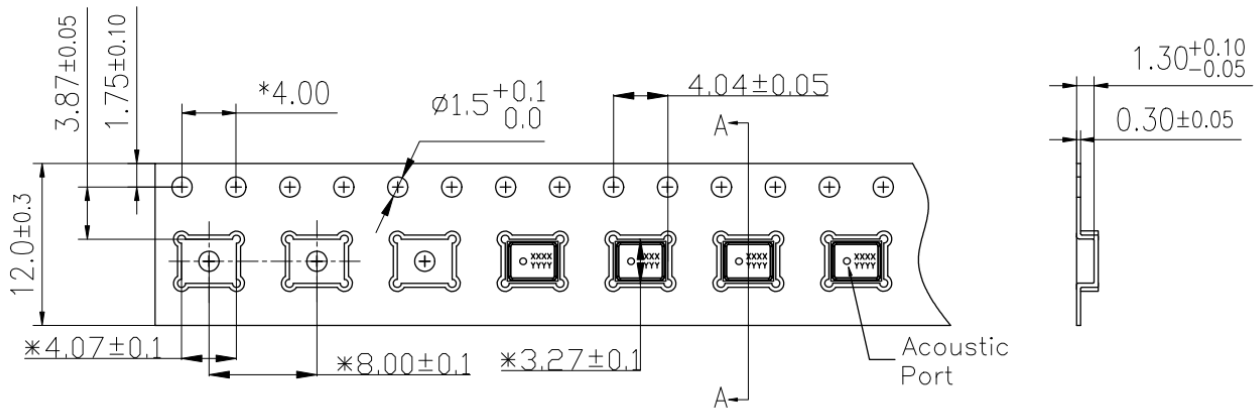

Model Number	Reel Diameter	Quantity Per Reel	Quantity Per Carton
ML-4259-3729-T1S1	13"	5,000	5,000 * 10 = 50,000Pcs

Notes:

- 1) Dice are packaged in black carrier band which uses anti-electrostatic material. Each volume of packaged products is 5000 pcs.
- 2) The space between two dice is 8mm packaged in the carrier band with 12-mm width rolled in the reel of 13-inch diameter.
- 3) The package requirements mentioned below is the company's standard delivery specifications. If you need special packages, please contact our sales staff.
- 4) All dimensions are in millimeters (mm) with tolerance of $\pm 0.3\text{mm}$.

● Materials statement

- Meets the requirements of the European RoHS directive 2011/65/EC as amended.
- Meets the requirements of the industry standard IEC 61249-2-21:2003 for halogenated substances and SV SensTech Green Materials Standards Policy section on Halogen-Free.

● Remarks

- MSL (moisture sensitivity level) Class 1.
- Maximum of 3 reflow cycles is recommended.
- In order to minimize device damage:
 - Do not board wash or clean after the reflow process.
 - Do not brush board with or without solvents after the reflow process.
 - Do not directly expose to ultrasonic processing, welding, or cleaning.
 - Do not insert any object in the port hole of device at any time.
 - Do not apply over 30 psi of air pressure into the port hole.
 - Do not pull a vacuum over the port hole of microphone.
 - Do not apply a vacuum when repacking into sealed bags at a rate faster than 0.5 atm/sec.

● Version updates

Version	Updated Content	Updated Date
1.0	Initial release	2019-02-19
1.1	Logo change	2021-10-14
1.2	Update Reliability specifications	2022-5-13

● Contact

SV SensTech Co., Ltd

Address: F2, No.200,
Linghu Avenue, Wuxi, Jiangsu,

Zip code 214135

Tel.: 86-510-85622282

Email: sales@svsens.com

Website: www.svsens.com

华景传感科技(无锡)有限公司

中国传感网国际创新园

江苏省无锡市新吴区菱湖大道200号F2栋

邮编: 214135

电话: (86) 0510-85622282

邮箱: sales@svsens.com

网页: www.svsens.com